

HR050/030L



HR050, 030L

Manipulator Specifications

Item		Specification	
Model		HR050	HR030L
Payload		50 kg	30 kg
Structure		Articulated	
Degree of freedom		6 Axes	
Max. Motion Range	S Swivel	±180°	
	H For/Backward	+150° ~ -80°	+150° ~ -77°
	V Up/Downward	+140° ~ -135°	+134° ~ -135°
	R2 Rotation 2	±360°	
	B Bending	±127°	
	R1 Rotation 1	±360°	
Max. Speed	S Swivel	150 °/s	140 °/s
	H For/Backward	170 °/s	150 °/s
	V Up/Downward	170 °/s	150 °/s
	R2 Rotation 2	235 °/s	210 °/s
	B Bending	235 °/s	210 °/s
Allowable Moment	R2 Rotation 2	18 kgf·m	12 kgf·m
	B Bending	18 kgf·m	12 kgf·m
	R1 Rotation 1	9 kgf·m	6 kgf·m
Repeatability		±0.07 mm	
Ambient Temperature		0 ~ 45°C (273 ~ 318°K)	
Approximate Weight		650 kg	670 kg

Working Envelope

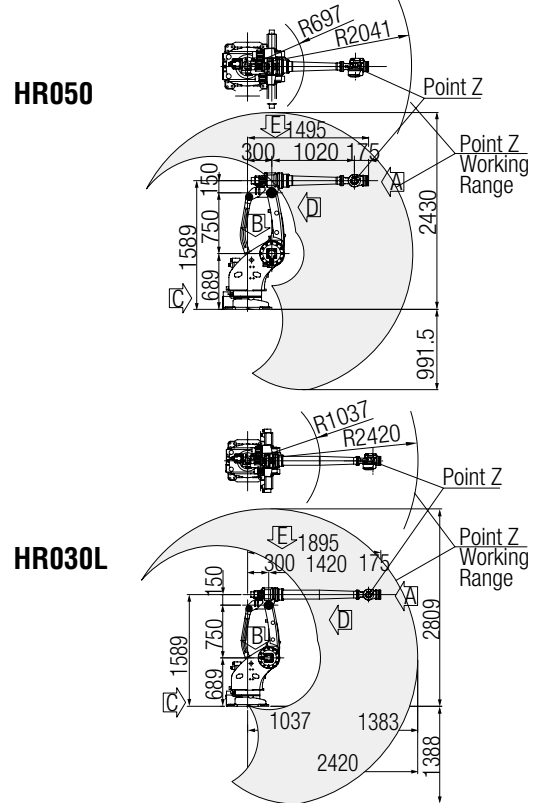

View "A" For Tool Attachment

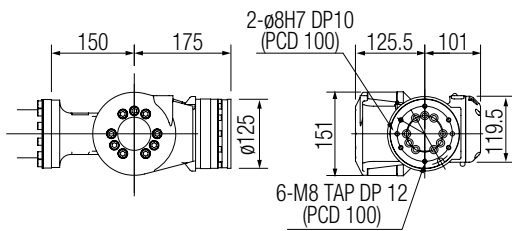

View "B" For Installation

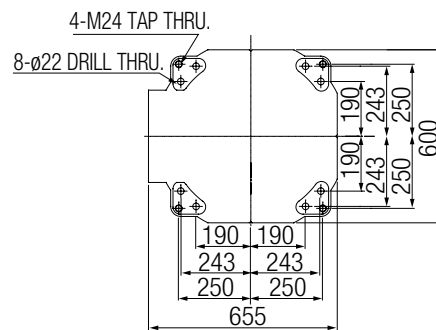

View "C" For User Application

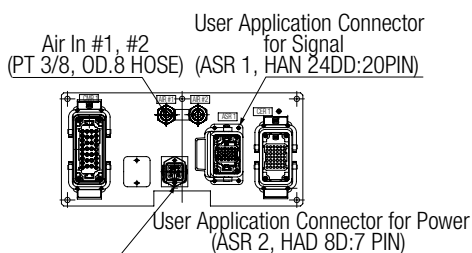

View "D" For User Application

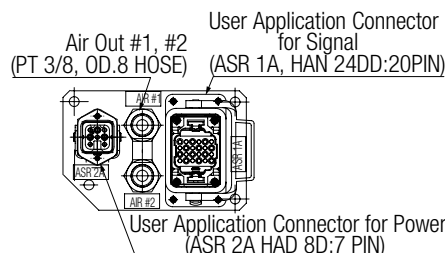

View "E" For Cable Guide

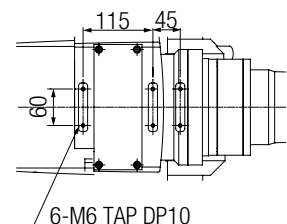

■ Controller Specifications

Item	Specification	
Model Name	Hi5	
Control Hardware	Multi Processor System	
Execution Mode	Teaching & Playback	
Interpolation Type	Point-to-Point, Linear, Circular	
Max. Axes	Max. 16 Axes Simultaneously	
Number of Step	17,000 Points	
External Program Selection	Binary 255 / Discrete 8	
Position Detector	Serial Absolute Encoder	
Program Back-up	USB Memory	
Servo Control	Full Digital Servo	
Digital Input / Output	Max. Input : 256 / Output : 256 Points	
Analog Input / Output	Input : 4 ch / Output : 4 ch	
Conveyor Pulse Counter	Differential Input / Open Collector Input, 2ch	
Communication	Ethernet	100BaseT (2 Ports)
	CAN	User1 / User2
	Serial	RS232C, RS422 (RS485)
	Field Bus	CC-Link, Profibus-DP, Devicenet, Modbus
Rated Supply Voltage	AC220V ± 10%, 50 / 60 Hz	
Max. Rated Power	8 kVA (Instant Max. 30 kVA)	
Cabinet Dimension (WxDxH)	650 mm x 600 mm x 1,100 mm (Except Caster)	
Weight	150 kg (Without Transformer)	
Protection Classification	IP54	
Ambient Temperature	0 ~ 45 °C	

■ Teaching Pendant Specifications

Item	Specification
Microprocessor	32 bits RISC Processor
Operating System	Windows CE
Display	7" Color TFT-LCD
Operation Mode	Menu Driven and Code Input / Touch Panel

· Easy and simple operation

- Easy/convenient programming language similar to BASIC

· Easy maintenance

- Excellent maintenance ability using on-line display function

· Advanced control technology

- Dynamic control
- Advanced vibration suppression control
- Extended torque-velocity control

· Safety

- Compliant with ANSI/RIA15.6_1999 and CE Directives

· Compatibility and connectivity

- Embedded soft PLC
- Fieldbus : CC-Link, Profibus-DP, Devicenet, Modbus, etc.
- Ethernet, Serial Communication

■ System Configuration

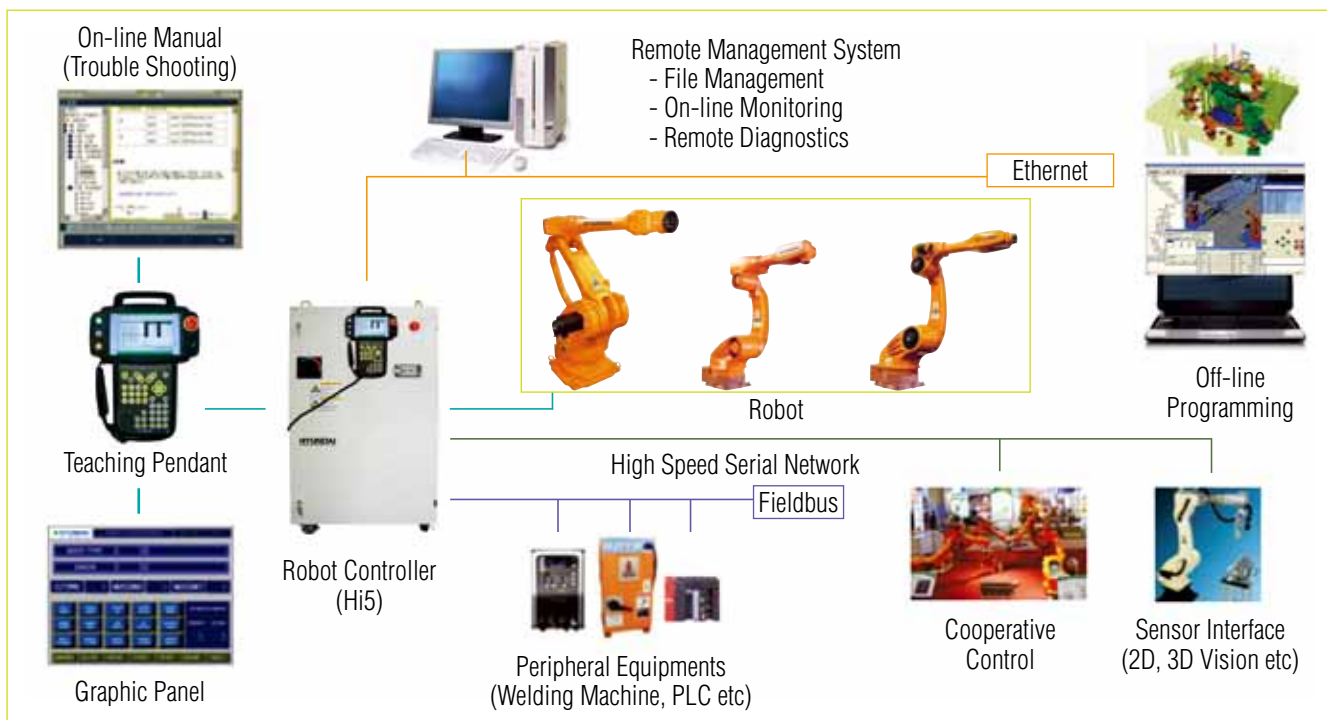



Key Features

- Enlargement of working envelope by link structure
- Improvement of dynamic performance



Application

- Material Handling
- Assembly
- Deburring



■ Certificate (ISO 9001, ISO 14001, QS-9000TE, CE) ■



Korea

Head Office

1, Jeonha-dong, Dong-gu, Ulsan
TEL : 82-52-202-7901~10 / FAX : 82-52-202-7900

Seoul Office

140-2, Gye-dong, Jongno-gu, Seoul
TEL : 82-2-746-4713 / FAX : 82-2-746-4720

Ansan Office

1431-2, Sa-dong, Sangnok-gu, Ansan-si, Gyeonggi-do
TEL : 82-31-409-4945 / FAX : 82-31-409-4946

Cheonan Office

355-15, Daga-dong, Cheonan-si, Chungcheongnam-do
TEL : 82-41-576-4294 / FAX : 82-41-576-4296

Daegu Office

223-5, Beomeo 2-dong, Suseong-gu, Daegu
TEL : 82-53-746-6232~3 / FAX : 82-53-746-6231

Gwangju Office

415-2, Nongseong-dong, Seo-gu, Gwangju
TEL : 82-62-363-5272 / FAX : 82-62-363-5273

Overseas

Chicago / U.S.A

955 Estes Avenue, Elk Grove Village IL
60007, U.S.A
TEL : +1 800 423 8721
FAX : +1 847 437 3574

Houston / U.S.A

1400 Broadfield, Suite 110, Park 10
Center Houston, Texas 77084, U.S.A
TEL : +1 281 578 7097
FAX : +1 281 578 8317

London / U.K

2ND Floor, The Triangle 5-17,
Hammersmith Grove London W6 0LG,
U.K
TEL : +44 20 8741 0501
FAX : +44 20 8741 5620/8834 7281

Rotterdam / Netherland

Folkert Elsingastraat 7
3067 NW, Rotterdam, The Netherland
TEL : +31 10 212 1567
FAX : +31 10 212 5134

Beijing / China

Beijing Hyundai Jingcheng
No.2, Nanli, Luguogiao
Fengtai District, Beijing, China
TEL : +86 10 8321 2588
FAX : +86 10 8321 2188

Mumbai / India

Hyundai Heavy Industries Co., Ltd.
301, 3rd Floor, Sarjan Plaza 100, Annie
Besant Road, Worli, Mumbai 400 018,
India
TEL : +91 22 2498 6022~7
FAX : +91 22 2498 0620



<http://www.hyundai-engine.com>
E-mail : robot@hhi.co.kr

*Materials and specifications are subject to change without notice